

E-M-HF63_65-V1_11	Rotronic AG Bassersdorf, Switzerland
Document code	Unit
HygroFlex HF63/HF65 Humidity Temperature Transmitters: User Guide	Instruction Manual
	Document Type
Document title	Page 1 of 34

HygroFlex HF63 and HF65 Humidity Temperature Transmitters

User Guide



E-M-HF63_65-V1_11	Rotronic AG Bassersdorf, Switzerland
Document code	Unit
HygroFlex HF63/HF65 Humidity Temperature Transmitters: User Guide	Instruction Manual
	Document Type
Document title	Page 2 of 34

Table of contents

1	Overview	3
2	Models	4
2.1	Ordering codes	4
2.2	Mechanical configurations and dimensions	8
2.3	Display and keypad option	8
3	General description	9
3.1	Power supply	9
3.2	Measured parameters	9
3.3	Calculated parameters	9
3.4	Analog output signals (HF63)	9
3.5	Digital interface (HF65)	10
3.6	Service connector	11
3.7	Sensor protection (dust filter)	11
3.8	Direct RTD option (HF63)	11
4	User configurable settings and functions	12
4.1	Function overview	12
4.2	Factory default settings	13
5	Mechanical installation	14
5.1	General guidelines	14
5.2	HF6 enclosure	15
5.3	Installation of the enclosure and probe	15
6	Electrical installation	16
6.1	General wiring guidelines	16
6.2	Guidelines for RS-485 wiring (HF65)	17
6.3	Cable grip and cable specifications	17
6.4	Wiring	18
7	Operation	21
7.1	Minimum load requirements for the HF63 with voltage outputs	21
7.2	HF63 transmitters (analog outputs)	22
7.3	HF65 (digital output)	22
7.4	Internal menu (optional keypad and display)	23
7.5	Displayed parameters (optional keypad and display)	24
8	Maintenance	24
8.1	Service cable	24
8.2	Location of the service connector (mini USB type)	25
8.3	Periodic calibration check	25
8.4	Cleaning or replacing the dust filter	26
8.5	Validation of the output signals transmission	26
9	Firmware updates	26
10	Technical data	27
10.1	Specifications	27
10.2	Dew point accuracy	30
11	Accessories	31
11.1	Configuration and communication software	31
11.2	Service cables	31
11.3	Mounting hardware	32
11.4	Calibration accessories	32
11.5	Dust filters for wall mount models	32
11.6	Dust filter parts for duct mount and cable probe models	33
12	Supporting documents	34
13	Document releases	34

E-M-HF63_65-V1_11 Document code	Rotronic AG Bassersdorf, Switzerland Unit
HygroFlex HF63/HF65 Humidity Temperature Transmitters: User Guide Document title	Instruction Manual Document Type
	Page 3 of 34

Applicability:

This manual applies to all instruments of the HF63 and HF65 series with firmware version 1.x, where 1.x can be 1.0, 1.1, etc. Changes to the last digit of the version number reflect minor firmware changes that do not affect the manner in which the instrument should be operated.

1 Overview

The HF6 transmitter series are designed for fixed installation in industrial applications. The HF6 measures relative humidity and temperature and can be configured to calculate the dew or frost point. Depending on the model, the HF6 can measure environments within the range of 0 to 100 %RH and -100 to 150°C (-148 to 302°F). The electronics operating range is limited to -40...60 °C (-10...60°C with the optional LC display).

The HF6 features well proven sensors and a robust housing. Digital signal processing ensures consistent product performance and also facilitates the task of field maintenance with features such as potentiometer free – digital calibration.

Based on the ROTRONIC AirChip 3000 digital technology the HF6 offers the following functions:

- User configurable settings
- Calculation of the dew or frost point
- Humidity temperature calibration and adjustment
- Simulator mode
- Automatic humidity sensor test and drift compensation
- Sensor failure mode
- Data recording

The ability for the user to easily update the AirChip 3000 firmware means that HF63 and HF65 transmitters can be kept up-to-date regarding any future functionality improvement.

HF63 transmitter with analog output signals: The HF63 features a 3-wire circuit with two voltage or two current output signals corresponding to relative humidity, temperature or to the dew or frost point. The analog outputs are linear and allow signal transmission over a length of cable to a remote display, recorder, controller or data processing unit. As an option, the HF63 is available with a second Pt100 RTD installed on the probe. When ordered with this option, the HF63 is supplied with an additional terminal block to allow a direct 4-wire connection with the RTD.

HF65 transmitter with digital interface only: the HF65 is a digital transmitter available with the following digital interface options: RS-485, USB + RS-485 or Ethernet (TCP/IP) + RS-485. Use of a digital interface allows the simultaneous reading of relative humidity, temperature and calculated parameter. The communication protocol used by the RS-485 interface offers several options that can be configured by the user. This includes a Modbus compatible protocol.

E-M-HF63_65-V1_11	Rotronic AG Bassersdorf, Switzerland
Document code	Unit
HygroFlex HF63/HF65 Humidity Temperature Transmitters: User Guide	Instruction Manual
	Document Type
Document title	Page 4 of 34

2 Models

2.1 Ordering codes

Transmitters with analog output signals: HF63 (3-wire)								
1	2	3	4	5	6	7	8	Circuit type, supply voltage and output signal type
HF631-								3-wire, 15 to 40 VDC or 12 to 28 VAC, 0...20 mA
HF632-								3-wire, 15 to 40 VDC or 12 to 28 VAC, 4...20 mA
HF633-								3-wire, 5 to 40 VDC or 5 to 28 VAC, 0...1 V
HF634-								3-wire, 10 to 40 VDC or 8 to 28 VAC, 0...5 V
HF635-								3-wire, 15 to 40 VDC or 12 to 28 VAC, 0...10 V
HF636-								3-wire, 85 to 265 VAC, 0...20 mA
HF637-								3-wire, 85 to 265 VAC, 4...20 mA
HF638-								3-wire, 85 to 265 VAC, 0...1 V
HF639-								3-wire, 85 to 265 VAC, 0...5 V
HF63A-								3-wire, 85 to 265 VAC, 0...10 V
Installation type / Mechanical configuration								
	2							Probe separated by 2 m cable, 15 x 100 mm
	D							Duct mount (through wall), probe 15 x 208 mm
	W							Wall mount, probe 15 x 85 mm
Parameters (analog outputs)								
		P					X X	Humidity (0...100 %RH) + direct 4-wire Pt100 RTD
		B						Humidity (0...100 %RH) and Temperature (see range below)
		H	X	X				Humidity only (0...100 %RH)
		T						Temperature only (see range below)
		1	X	X				Humidity & Dew / Frost point (see range below)
		A						Dew / Frost point and Temperature (see range below)
Standard temperature output ranges								
			1	X				0...50 °C
			2	X				10...40 °C
			3	X				-40...60 °C
			4	X				-30...70 °C
			5	X				-40...85 °C
			6	X				0...100 °F
			7	X				0...200 °F
			8	X				0...300 °F

E-M-HF63_65-V1_11	Rotronic AG Bassersdorf, Switzerland
Document code	Unit
HygroFlex HF63/HF65 Humidity Temperature Transmitters: User Guide	Instruction Manual
	Document Type
Document title	Page 5 of 34

1	2	3	4	5	6	7	8	Standard temperature output ranges
			9 X					-50...200 °F
			S T					Custom range. Specify when ordering
		P P	3					Pt 100 1/3 class B, 4-wire direct connection
		P P	5					Pt 100 1/5 class B, 4-wire direct connection
		P P	A					Pt 100 1/10 class B, 4-wire direct connection
								Optional keypad and display
				D				Keypad and display with backlight
				X				No keypad and display
								Probe length options (except wall mount configuration)
					S			Standard length
					1			Standard length + 150 mm
					2			Standard length + 300 mm
					3			Standard length + 450 mm
					4			Standard length +600 mm
								Cable fittings
						1		1x M16 cable grip (85 to 265 VAC: 2 cable grips)
						3		1x 1/2" conduit adapter (85 to 265 VAC: 2 conduit adapters)
								Standard dew / frost point output ranges
							X X	No calculated parameter
							B X	-50...50 (°C / °F - as per temperature output range)
							C X	-50...100 (°C / °F - as per temperature output range)
							D X	-50...200 (°C / °F - as per temperature output range)
							S C	Custom range. Specify when ordering

Notes:

- Output 1: relative humidity or dew point
- Output 2: temperature
- The enclosure of all HF6 models is designed to be installed in the horizontal position
- Cable grips are located at the bottom of the enclosure (models with 85 to 264 VAC supply voltage have 2 cable grips)
- Conduit adapters are located on top of the enclosure (models with 85 to 264 VAC supply voltage have 2 conduit adapters)
- The dew / frost point range uses the same unit (°C or °F) as the temperature output. The factory default setting is frost point below freezing.
- Custom range: be sure to clearly specify the desired range at the time of the order. When a special range has been ordered, the letters ST and SC are used in columns 4 and 7 in the above table. These generic codes will be replaced with a specific code only for quantity and repeat orders

E-M-HF63_65-V1_11	Rotronic AG Bassersdorf, Switzerland
Document code	Unit
HygroFlex HF63/HF65 Humidity Temperature Transmitters: User Guide	Instruction Manual
	Document Type
Document title	Page 6 of 34

Transmitters with digital interface only: HF65							
1	2	3	4	5	6	7	Circuit type and supply voltage
HF656-							5 to 40 VDC or 12 to 24 VAC
HF658-							85 to 265 VAC
Installation type / Mechanical configuration							
	2						Probe separated by 2 m cable, 15 x 100 mm
	D						Duct mount (through wall), probe 15 x 208 mm
	W						Wall mount, probe 15 x 85 mm
Parameters							
		X					Humidity & Temperature
		1					Humidity & Temperature & Dew-/ Frost point
Optional keypad and display							
			D				Keypad and display w. backlight
			X				No keypad and display
Probe length options (except wall mount configuration)							
				S			Standard length
				1			Standard length + 150 mm
				2			Standard length + 300 mm
				3			Standard length + 450 mm
				4			Standard length +600 mm
Cable fittings and digital interface							
					5		M16 cable grip, RS-485 interface
					6		1/2" conduit adapter, RS-485 interface
					7		M16 cable grip, USB + RS-485
					8		1/2"conduit adapter, USB + RS-485
					9		M16 cable grip, Ethernet + RS-485
					A		1/2" conduit adapter, Ethernet + RS-485
					B		M16 cable grip, Ethernet wireless + RS-485
					C		1/2" conduit adapter, Ethernet wireless + RS-485
					D		M16 cable grip, MODBUS ASCII interface
					E		1/2" conduit adapter, MODBUS ASCII interface
Unit system							
						M	Metric
						E	English

E-M-HF63_65-V1_11 Document code	Rotronic AG Bassersdorf, Switzerland Unit
HygroFlex HF63/HF65 Humidity Temperature Transmitters: User Guide Document title	<div style="text-align: right;"> Instruction Manual Document Type </div> <hr/> Page 7 of 34

Notes:

- The enclosure of all HF6 models is designed to be installed in the horizontal position
- Cable grips are located at the bottom of the enclosure (models with 85 to 264 VAC supply voltage have 2 cable grips)
- Conduit adapters are located on top of the enclosure (models with 85 to 264 VAC supply voltage have 2 conduit adapters)
- The factory default setting for the dew point calculation is the frost point below freezing
- The same terminal block is used for either the Modbus interface or the RS-485 interface. A MODBUS network and a RS-485 network are physically identical and differ only in the communication protocol being used. The default communication protocol used with the RS-485 interface is RO-ASCII. When ordered with the MODBUS interface, the transmitter is configured by the factory to use the MODBUS ASCII communication protocol

E-M-HF63_65-V1_11	Rotronic AG Bassersdorf, Switzerland
Document code	Unit
HygroFlex HF63/HF65 Humidity Temperature Transmitters: User Guide	Instruction Manual
	Document Type
Document title	Page 8 of 34

2.2 Mechanical configurations and dimensions

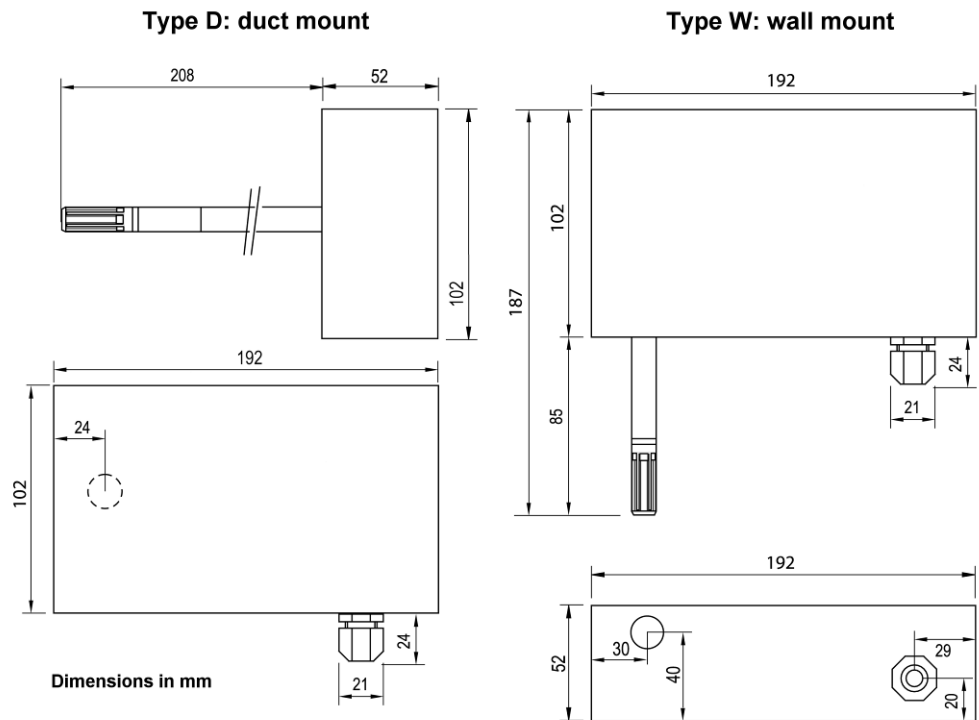

2.3 Display and keypad option

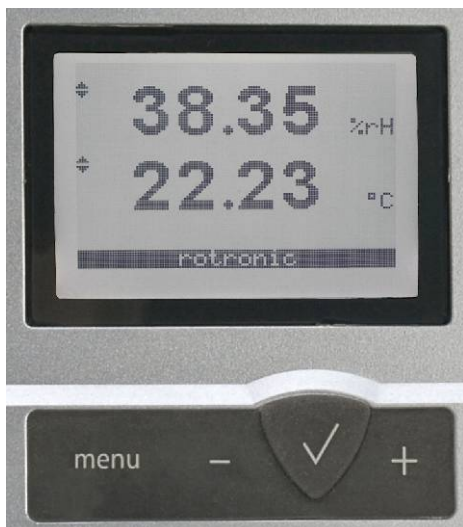

The LC display option of both the HF63 and HF65 features a backlight.

The upper line corresponds to relative humidity or dew / frost point and the bottom line corresponds to temperature.

The display can be configured to show a trend indicator on each line:

- ▲ : increasing value
- ▼ : decreasing value

In the event of an alarm the display shows the symbol [!] to the right of the value.

For instructions see the following HW4 manual: **E-M-HW4v2-F2-008**.

E-M-HF63_65-V1_11	Rotronic AG Bassersdorf, Switzerland
Document code	Unit
HygroFlex HF63/HF65 Humidity Temperature Transmitters: User Guide	Instruction Manual
	Document Type
Document title	Page 9 of 34

3 General description

3.1 Power supply

Depending on the circuit type, the HF6 requires the following power supply:

- a) **HF631 to HF635** (3-wire with analog outputs): 15 to 40 VDC (see note below) or 12 to 28 VAC. With both output circuits closed, the maximum current consumption is 50 mA.

Note: depending on the type of output signal, the HF63 will operate with the following minimum voltage

0...1 V outputs:	5 VDC or 5 VAC
0...5 V outputs:	10 VDC or 8 VAC
0...10 V outputs:	15 VDC or 12 VAC
0...20 mA or 4 ...20 mA outputs:	6 VDC or 5 VAC with 0 Ω load 15 VDC or 12 VAC with 500 Ω load

- b) **HF636 to HF63A** (3-wire with analog outputs): 85 to 265 VAC

- c) **HF656** (3-wire) with digital outputs: 5 to 40 VDC or 12 to 28 VAC. Maximum current consumption:

Model with USB interface:	50 mA
Model with Ethernet (TCP/IP) interface:	300 mA

- d) **HF658** (3-wire with digital outputs): 85 to 265 VAC

3.2 Measured parameters

The HF63 and HF65 measure relative humidity with a ROTRONIC Hygromer[®] IN1 capacitive sensor and temperature with a Pt100 RTD.

3.3 Calculated parameters

Using the ROTRONIC HW4 software, the HF63 or HF65 can be configured by the user to calculate either the dew point or the frost point.

3.4 Analog output signals (HF63)

With the ROTRONIC HW4 software any analog output signal can be made to correspond to one of the following:

- Relative humidity
- Temperature
- Calculated parameter

Any output can also be disabled.

The scale of each analog output can be set within the numerical limits of -999.99 and 9999.99.

E-M-HF63_65-V1_11 Document code	Rotronic AG Bassersdorf, Switzerland Unit
HygroFlex HF63/HF65 Humidity Temperature Transmitters: User Guide Document title	Instruction Manual Document Type
	Page 10 of 34

The D/A converters used to generate the analog output signals feature a 16-bit resolution and exhibit a small positive offset at the bottom of the signal range as indicated below:

Signal type	Maximum offset at range bottom
0...1 V	3 mV
0...5 V	50 mV
0...10 V	90 mV
0...20 mA	4 μ A
4...20 mA	No offset

The ROTRONIC HW4 software allows changing the type of output signal to one of the following: 0...20 mA, 4...20 mA, 0...1V, 0...5V or 0...10V. Both output signals are automatically configured with the same signal type. No calibration or adjustment is required after changing the type of output signal.

3.5 Digital interface (HF65)

a) RS-485 serial interface

The HF65 has always a RS-485 serial interface. When the number of available network ports is limited, this interface can be used to connect together up to 64 devices in a multi-dropped arrangement. In principle, an unlimited number of such networks can be monitored with the HW4 software, but each RS-485 multi-drop network is limited to 64 devices. The HF65 can be used either as a slave or a master, without special configuration. The master is automatically the device that is directly connected to a network (PC or LAN) by means of a USB port or TCP/IP port.

RS-485 Compatibility: The communication protocol used by the HF65 and other AirChip 3000 products is not compatible with the protocol used by the previous generation of ROTRONIC instruments. Do not connect legacy products and AirChip 3000 products to the same RS-485 multi-drop network.

b) USB or Ethernet interface

The HF65 is also available with the following interface combinations: USB + RS-485 or Ethernet +RS-485. In that case the protection grade of the HF6 enclosure is no longer IP65 / NEMA 4 rated.

c) Communication protocol options

The measurement data can be read without having to use the ROTRONIC HW4 software. Starting with firmware version 1.3, the HF65 offers the following communication protocol options (ASCII) which can be selected by connecting the HF65 to a PC running the ROTRONIC HW4 software (version 2.1.1 or higher):

- **RO-ASCII:** this is the standard (default) communication protocol used by all AirChip 3000 devices and by the HW4 software. In principle, this protocol supports all of the AirChip 3000 functions but some of the functions require a certain amount of computations to be carried out by an external device such as a PC.
- **Custom:** this communication protocol can be used to provide compatibility of the HF65 with an existing communication system. The Custom communication protocol is limited to reading measurement data from the HF65. Functions such as device configuration, humidity and temperature adjustment, etc. are not supported. The Custom protocol is applicable to all AirChip 3000 devices with a digital interface and allows RS-485 networking

E-M-HF63_65-V1_11	Rotronic AG Bassersdorf, Switzerland
Document code	Unit
HygroFlex HF63/HF65 Humidity Temperature Transmitters: User Guide	Instruction Manual
	Document Type
Document title	Page 11 of 34

- **Modbus:** the Modbus protocol available with the HF65 is limited to reading measurement data from the HF65. Functions such as device configuration, humidity and temperature adjustment, etc. are not supported by the Modbus protocol.

When using either the RO-ASCII or the Custom protocol, the HF65 can be set to send data automatically after each refresh cycle without requiring a data request. When this mode is enabled, the receiving device must be listening at all times in order to get the measurement data.

For details, see document **E-M-AC3000-CP**

3.6 Service connector

The service connector (UART interface with a mini-USB type connector) allows connecting the HF6 either to a PC running the ROTRONIC HW4 software or to a probe input of another instrument that is compatible with the HygroClip 2 (HC2) probes. In both cases a service cable is required. See "Maintenance" for the location of the service connector and for the type of service cable to be used.

- Connecting the HF63 or HF65 to a PC is used to configure the HF6, gain access to the HF6 functions such as humidity and temperature adjustment, read data from the HF6 on the PC and update the AirChip 3000 firmware.
- Connecting the HF6 to the probe input of another instrument is useful only when the other instrument has its own display and keypad, and has an internal menu equivalent to the menu of the HP23 hand-held calibrator. The connection allows showing the data measured by the HF6 on the other instrument display and also allows using the other instrument internal menu to do for example a humidity and temperature adjustment of the HF6.
- **HF65 (digital outputs):** the USB, Ethernet and RS-485 interfaces offer the same functionality as the service connector but do not allow connecting the HF6 to a HP23 hand-held calibrator.

3.7 Sensor protection (dust filter)

The probe of the HF6 requires a filter to protect the sensors against dust particles and high air velocity.

Wall mount models: the probe of the HF6 is equipped with a slotted cap with a Polyethylene insert

Duct mount and cable probe models: the probe of the HF6 is equipped with a with a metal filter base mod. NSP-ME. The filter cartridge must be ordered separately (see Accessories 11.7). Filter cartridge mod. SP-M15 is suitable for most applications.

3.8 Direct RTD option (HF63)

The standard H63 is equipped with one Pt100 RTD. When ordered with the direct RTD option, the HF63 is supplied with a second Pt100 RTD installed on the probe. This additional RTD is directly connected to a terminal block. (4-wire connection)

E-M-HF63_65-V1_11	Rotronic AG Bassersdorf, Switzerland
Document code	Unit
HygroFlex HF63/HF65 Humidity Temperature Transmitters: User Guide	Instruction Manual
	Document Type
Document title	Page 12 of 34

4 User configurable settings and functions

The HF6 ships configured as specified on the customer order. Models with analog outputs can be installed and used just as any conventional humidity and temperature transmitter and most users will never need to use the HF6 configurable settings and functions. Models with a digital interface generally require some configuration by the user.

Making use of the HF6 configurable settings and functions is entirely up to the user and the appropriate settings depend on the user application. We have provided below a short description of the HF6 functions and also indicated the factory default settings.

4.1 Function overview

MEASUREMENT ACCURACY AND RELIABILITY	
AirChip 3000 Functions	Description
▶ Humidity / temperature adjustment	<ul style="list-style-type: none"> ○ 1-point or multi-point humidity calibration or adjustment ○ 1-point or 2-point temperature calibration or adjustment ○ Generate a time stamp for calibrations and adjustments ○ Retain and view last adjustment date and adjustment values ○ Generate calibration and adjustment protocols
▶ Automatic humidity sensor test and optional drift compensation	<p>Tests the humidity sensor for drift caused by contaminants and can be used to automatically apply a correction. The test is automatically carried out at regular intervals of time. Can be configured, enabled, or disabled</p> <p>The humidity sensor status can be verified either with the HW4 software or with the instrument display (if available) and is shown as Good, SQ-tuned (corrected for drift) or Bad (defective)</p>
▶ Data recording	<p>The data recording function differs from a true data logging function in the sense that the AirChip 3000 does not time stamp the data. This data recording function can be used to investigate events such as a sensor malfunction as well as to retrieve data that would otherwise be lost</p> <ul style="list-style-type: none"> ○ Start or stop data recording - up to 2000 value pairs (%RH and temperature). Starting a recording session erases all previously recorded data ○ The recording mode and log interval can be specified ○ When the device is powered off, the recording session is paused but not ended. As long as the recording session has not been ended, the device automatically resumes recording data when powered up again ○ The recorded data can be downloaded to a PC with the HW4 software, time stamped and viewed
MEASUREMENT LOOP VALIDATION	
AirChip 3000 Functions	Description
▶ Simulator mode	Used to make the HF6 generate fixed values for the humidity, temperature and calculated parameter. Can be configured, enabled or disabled

E-M-HF63_65-V1_11 Document code	Rotronic AG Bassersdorf, Switzerland Unit
HygroFlex HF63/HF65 Humidity Temperature Transmitters: User Guide Document title	Instruction Manual Document Type
	Page 13 of 34

DEVICE SAFEGUARDS	
AirChip 3000 Functions	Description
▶ Device write protection	Used to protect the HF6 with a password to prevent unauthorized digital access by a digital user. Can be configured, enabled or disabled
▶ Internal menu access from keypad	Used to prevent accidental changes to the HF6 settings and temperature-humidity adjustment by disabling the MENU key on the optional keypad. Can be enabled or disabled

PROCESS PROTECTION / PROTECTION OF OTHER DEVICES	
AirChip 3000 Functions	Description
▶ Limit humidity output to 100 %RH	Used to prevent the humidity signal from exceeding 100 %RH when condensation forms on the sensor. Can be enabled or disabled
▶ Out-of-limit value alarm	Used to specify the normal range for humidity, temperature and the calculated parameter depending on the user application. Can be configured, enabled or disabled Out-of-limit values trigger a digital alarm which can be also be seen on the optional display
▶ Bad sensor alarm	Built-in function. Cannot be disabled A bad humidity or temperature sensor triggers a digital alarm which can be also be seen on the optional display
▶ Fail safe mode	Used to specify a "safe" fixed value for humidity and for temperature in the event of a sensor failure. Can be configured, enabled or disabled

4.2 Factory default settings

Notes:

- Configuration of the HF6 by the user and access to its functions requires a PC with the ROTRONIC HW4 software (version 2.1.1 or higher) installed. Service cable AC3006 or AC3009 is used to connect the HF6 service connector to a USB port of the PC. The HF65 can also be connected to the PC using either its USB, Ethernet or RS-485 interface
- Settings and functions that can also be either partially or fully accessed from the optional keypad are marked with the letter **K** (see also Operation > Internal Menu).

Configurable Settings		Applicability	Factory default
Unit system (Metric or English)	K	HF63, HF65	As per ordering code
Analog signal type (4...20 mA or other)		HF63	As per ordering code
Psychrometric calculation		HF63, HF65	As per ordering code
Output 1 parameter, scale and unit		HF63	As per ordering code (%RH or DP)
Output 2 parameter, scale and unit		HF63	Temperature, unit as per ordering code
Display resolution (optional)		HF63, HF65	1 decimal
Display backlight (optional)	K	HF63, HF65	Always on
Displayed parameters	K	HF63, HF65	As per ordering code

E-M-HF63_65-V1_11	Rotronic AG Bassersdorf, Switzerland
Document code	Unit
HygroFlex HF63/HF65 Humidity Temperature Transmitters: User Guide	Instruction Manual
	Document Type
Document title	Page 14 of 34

Configurable Settings	Applicability	Factory default
Trend indicator (display)	HF63, HF65	Enabled
Communication protocol	HF65	RO-ASCII
RS-485 address	HF65	0
TCP/IP settings	HF65	See document E-M-TCPIP-Conf
Device name	HF63, HF65	Instrument model

Functions		Applicability	Factory default
Humidity / temperature adjustment	K	HF63, HF65	
Device write protection		HF63, HF65	Disabled
Menu access from keypad		HF63, HF65	Enabled
Limit humidity output to 100 %RH		HF63, HF65	Enabled
Out-of-limit value digital / display alarm		HF63, HF65	Disabled
Data recording	K	HF63, HF65	Enabled (loop mode – 10 min. interval)
Automatic humidity sensor test		HF63, HF65	Disabled
Humidity sensor drift compensation		HF63, HF65	Disabled
Fail safe mode		HF63, HF65	Disabled
Simulator mode		HF63, HF65	Disabled

- For a detailed description of all AirChip 3000 / HF6 main functions see document **E-T-AC3000-DF-V1**
- Instructions regarding the configuration of the HF6 and access to its functions are provided in the following manuals:
 - E-M-HW4v2-F2-008**
 - E-M-HW4v2-Main** (§ 6.5)
 - E-M-HW4v2-DR-001**
 - E-M-HW4v2-A2-001**
 - E-M-AC3000-CP**
- Instructions for configuring the TCP/IP settings of the HF65, are provided in document **E-M-TCPIP-Conf**
- The factory default setting for dew / frost point calculation is frost point below freezing

5 Mechanical installation

5.1 General guidelines

Relative humidity is extremely dependent on temperature. Proper measurement of relative humidity requires that the probe and its sensors be at exactly the temperature of the environment to be measured. Because of this, the location where you choose to install the probe can have a significant effect on the performance of the instrument. The following guidelines should guarantee good instrument performance:

- a) **Select a representative location:** install the probe where humidity, temperature and pressure conditions are representative of the environment to be measured.
- b) **Provide good air movement at the probe:** air velocity of at least 200 ft/ minute (1 meter/second) facilitates adaptation of the probe to changing temperature.

E-M-HF63_65-V1_11	Rotronic AG Bassersdorf, Switzerland
Document code	Unit
HygroFlex HF63/HF65 Humidity Temperature Transmitters: User Guide	Instruction Manual
	Document Type
Document title	Page 15 of 34

- c) **Avoid the following:** (1) Close proximity of the probe to a heating element, a cooling coil, a cold or hot wall, direct exposure to sun rays, etc. (2) Close proximity of the probe to a steam injector, humidifier, direct exposure to precipitation, etc. (3) Unstable pressure conditions resulting from excessive air turbulence.
- d) **Immerse as much of the probe as possible in the environment to be measured.**
- e) **Prevent the accumulation of condensation water at the level of the sensor leads.** Install the probe so that the probe tip is looking downward. If this is not possible, install the probe horizontally.

5.2 HF6 enclosure

The HF6 enclosure consists of a base and a cover held together with 4 screws. To open the enclosure, use a metric 3 mm hex key. Prior to re-assembling the enclosure, verify that the red seal is sitting properly in its groove on the base.

5.3 Installation of the enclosure and probe

Mounting position of the enclosure

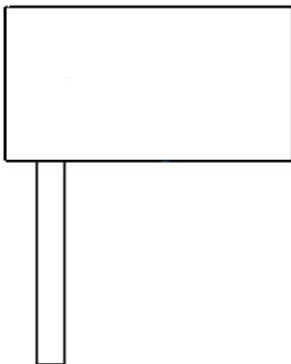

The enclosure of the HF6 is designed to be mounted in a horizontal position as illustrated here for the HF6 type W

Mounting hardware for the enclosure (HF6 type W and HF6 with cable probe)

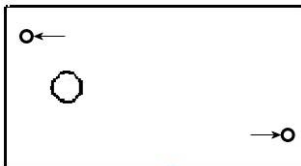

Method 1: The HF6 is supplied with 2 screws, 2 drywall anchors and two rubber washers. The base of the enclosure has 2 screw-wells (see drawing) that are normally closed at the bottom. Use the template provided with the HF6 to drill mounting holes in the wall and insert the drywall anchors. Place a rubber washer on each screw. Insert a screw in each well and push to open the bottom of the well.



Method 2: When a DIN-rail (35 mm / 1 3/8") is available use part **AC5002** (not included). This is a DIN-rail mounting kit consisting of 2 clamps that attach to the back of the enclosure with the screws provided.

E-M-HF63_65-V1_11 Document code	Rotronic AG Bassersdorf, Switzerland Unit
HygroFlex HF63/HF65 Humidity Temperature Transmitters: User Guide Document title	Instruction Manual Document Type
	Page 16 of 34

Mounting hardware for the probe (HF6 type D and HF6 with cable probe)



Use parts **AC1303-M** (compression fitting) and **AC1305** (flange) to hold and seal the probe when mounted through a wall (see Accessories).

- The enclosure of the HF6 type D does not require any additional support.
- The enclosure of the HF6 with cable probe can be installed in the same manner as the enclosure of the HF6 type W.

6 Electrical installation

6.1 General wiring guidelines

Power supply wiring

Heavy machinery and instrumentation should not share the same power supply wiring. If this cannot be avoided, noise filters and surge protectors should be used. Most UPS devices have those features already integrated.

General guidelines for signal cables

The following guidelines are derived from European Standard EN 50170 for the transmission of signals by copper wires. When planning an installation, the rules provided by EN 50170 should be followed under consideration of local circumstances to determine the position of machines and equipment.

All ROTRONIC products are tested for Electromagnetic Compatibility according to EMC Directive 2004/106/EG and following European standards:

- EN 61000-6-1: 2001, EN 61000-6-2: 2005
- EN 61000-6-3: 2005, EN 61000-6-4: 2001 + A11

Whenever the level of electromagnetic interference is expected to be high, both the instruments and signal cables should be placed as far away as possible from the source of interference.

In general, signal cables should be installed in bundles or channels / conduits, separate from other cables as indicated in the table below:

E-M-HF63_65-V1_11	Rotronic AG Bassersdorf, Switzerland
Document code	Unit
HygroFlex HF63/HF65 Humidity Temperature Transmitters: User Guide	Instruction Manual
	Document Type
Document title	Page 17 of 34

<ul style="list-style-type: none"> • Bus signals such as RS485 • Data signals for PCs, printers etc. • shielded analog inputs • unshielded direct current (<= 60V) • shielded process signals (<= 25 V) • unshielded alternate current (<= 25V) • coaxial cables for CRT monitors 	in common bundles or channels / conduits
<ul style="list-style-type: none"> • direct current from 60 V to 400 V (unshielded) • alternate current from 25V to 400 V (unshielded) 	in separated bundles or channels / conduits, without minimum distance
<ul style="list-style-type: none"> • direct and alternate current > 400 V (unshielded) • Telephone lines • lines leading into EX-rated areas 	in separated bundles or channels / conduits, without minimum distance

Lightning protection

Cabling in areas with a risk of lightning requires a lightning protection. For cabling underground in between buildings, we recommend the use of special fiber optic cables. If this is not possible, use copper cables that are suitable for underground installation.

6.2 Guidelines for RS-485 wiring (HF65)

See document **E-DV04-RS485.01**: RS485 Network Installation and Start-up Guidelines

6.3 Cable grip and cable specifications

The HF6 is supplied with either one or two M16 sealing cable grips or one or two 1/2" conduit adapters. The M16 cable grip provides effective sealing only with cables having the proper outside diameter. Preferably, use a cable with an outside diameter of 6 to 7 mm (0.236 to 0.275 inch) with 18 AWG wires.

E-M-HF63_65-V1_11	Rotronic AG Bassersdorf, Switzerland
Document code	Unit
HygroFlex HF63/HF65 Humidity Temperature Transmitters: User Guide	Instruction Manual
	Document Type
Document title	Page 18 of 34

6.4 Wiring

6.4.1 HF631 to HF63A: 3-wire analog transmitter

Electrical diagram 15 to 40 VDC or 12 to 28 VAC power supply with voltage outputs

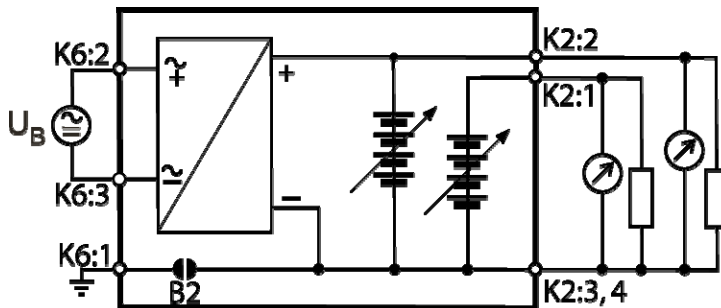

Electrical diagram 85 to 265 VAC power supply with voltage outputs

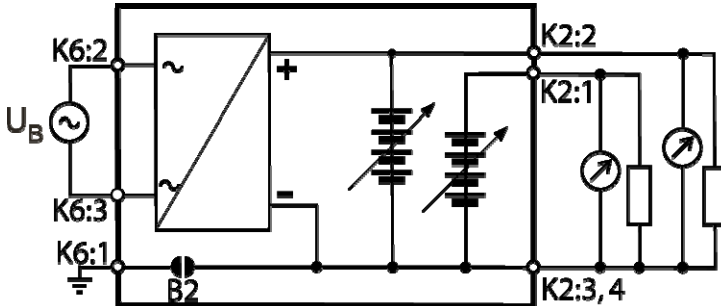

The maximum permissible cable length can be determined under consideration of the voltage drop caused by the current flowing to the devices connected to the unit. The voltage drop in the cable depends both on cable resistance and on the equivalent resistance of the devices connected in parallel to the unit. The total resistance connected to each unit output should be at least 1000 ohms. Cable resistance should not be more than 1/1000 of the load resistance.

E-M-HF63_65-V1_11

Rotronic AG
Bassersdorf, Switzerland

Document code

Unit

HygroFlex HF63/HF65 Humidity Temperature Transmitters: User Guide

Instruction Manual

Document Type

Document title

Page 19 of 34

Electrical diagram 15 to 40 VDC or 12 to 28 VAC power supply with current outputs

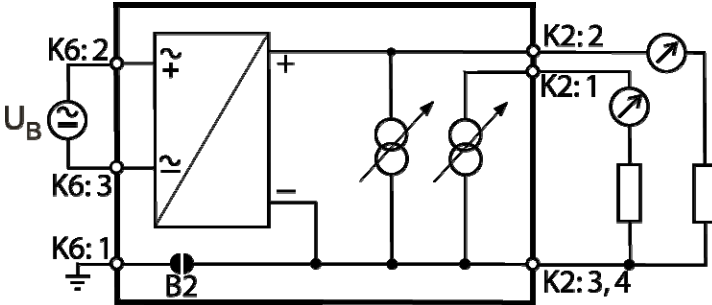

Electrical diagram 85 to 265 VAC power supply with current outputs

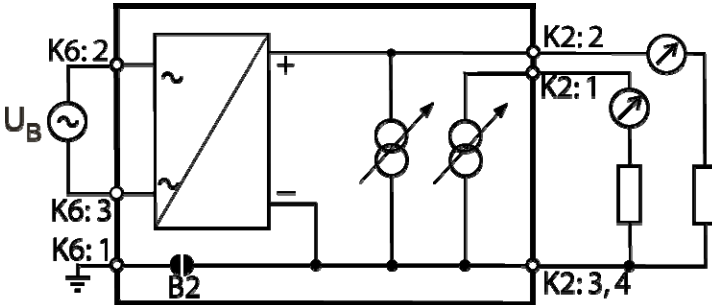

The maximum permissible cable length, connecting the unit to other devices, is determined by the total resistance resulting from the addition of the cable resistance and that of the devices connected in series with the unit. This resistance should not exceed 500 ohms.

Terminal block diagram

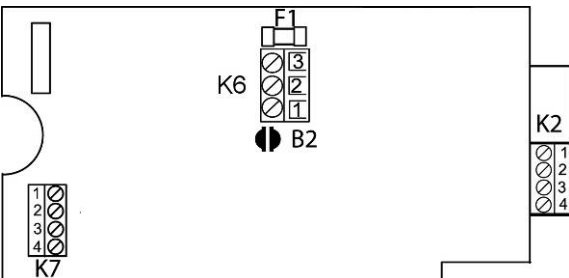

Terminals	Description
K6-1: ->	General ground (see note below)
K6-2: +	Power supply: 15...40 VDC (+) or VAC - Phase
K6-3: -	Power supply (-) or VAC - neutral

Terminals	Description
K2-1: OUT 1	Relative humidity or dew point (+)
K2-2: OUT 2	Temperature output (+)
K2-3: GND	Ground (tied with other GND)
K2-4: GND	Ground (tied with other GND)

E-M-HF63_65-V1_11	Rotronic AG Bassersdorf, Switzerland
Document code	Unit
HygroFlex HF63/HF65 Humidity Temperature Transmitters: User Guide	Instruction Manual
	Document Type
Document title	Page 20 of 34

Note: Terminal K6-1 is not tied with GND. If so desired, this terminal can be tied with GND by closing solder pad B2 on the PCB

Optional terminal block - Pt100 direct

Terminals	Description
K7-1	Pt100 direct - S
K7-2	Pt100 direct - AS
K7-3	Pt100 direct – AR
K7-4	Pt100 direct - R

Terminal block K7 is used only when the HF63 is equipped with an additional Pt100 RTD installed on the probe

Measuring humidity or temperature only

Operation of the HF63 does not require both current loops to be closed. When using the HF63 to measure either humidity only or temperature only, close only the loop that is being used.

Using the ROTRONIC HW4 software, any unused output of the HF63 can be disabled.

6.4.2 HF656 and HF658: digital outputs only

WARNING: Connecting a device to an active Ethernet network can disrupt communications on the network. Before connecting the HF6, make sure that it is properly configured for your network

Terminal block diagram

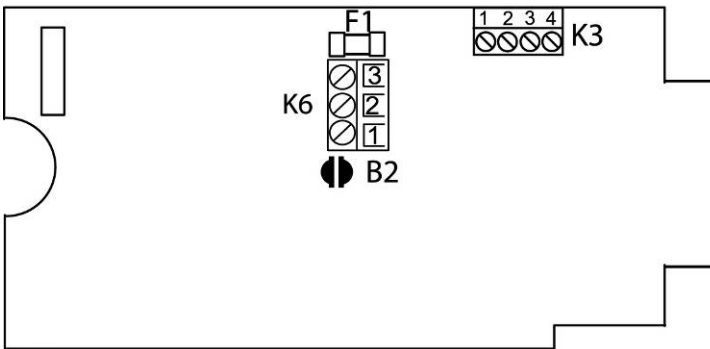

Terminals	Description
K6-1: -▶	General ground (see note)
K6-2: +	Power supply: 15...40 VDC (+) or VAC - Phase
K6-3: -	Power supply (-) or VAC - neutral

Note: Terminal K6-1 is not tied with GND. If so desired, this terminal can be tied with GND by closing solder pad B2 on the PCB

E-M-HF63_65-V1_11	Rotronic AG Bassersdorf, Switzerland
Document code	Unit
HygroFlex HF63/HF65 Humidity Temperature Transmitters: User Guide	Instruction Manual
	Document Type
Document title	Page 21 of 34

RS-485 terminal block

Terminals	Description
K3-1: PWR	DC (+) 15...40 VDC (+) (optional, see note below)
K3-2: GND	Ground / Power supply (-)
K3-3: D+	RS-485 Bi-directional TX+ / RX +
K3-4: D-	RS-485 Bi-directional TX- / RX -

Pins K3-1 and K3-2 can be used to power all instruments on a RS-485 multi-drop from a single external DC power supply with adequate mA rating. In that case, do not use pin K6-2 and pin K6-3 (normally used to power the HF65).

6.4.3 Grounding (all models)

We generally recommend grounding the (-) side of the power supply, especially if the electronics will be subjected to a low humidity environment (35 %RH or less).

7 Operation

7.1 Minimum load requirements for the HF63 with voltage outputs

The following requirements apply to any external device or circuit connected to the HF63 transmitter with voltage outputs:

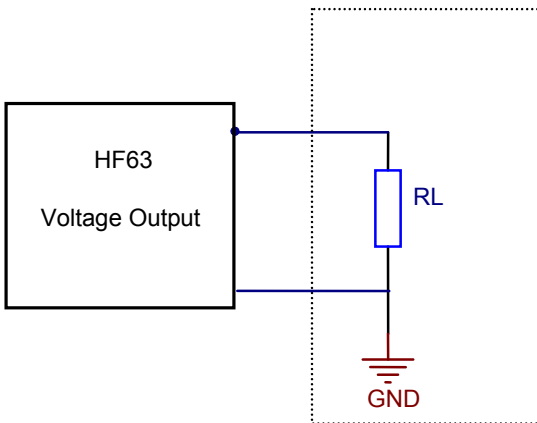

HF63 output signal	Input resistance RL
0...1V	$\geq 1\text{k}\Omega$
0...5V	$\geq 5\text{k}\Omega$
0...10V	$\geq 10\text{k}\Omega$

E-M-HF63_65-V1_11	Rotronic AG Bassersdorf, Switzerland
Document code	Unit
HygroFlex HF63/HF65 Humidity Temperature Transmitters: User Guide	Instruction Manual
	Document Type
Document title	Page 22 of 34

In the situation where the external device uses an internal pull-up resistor the value of this resistor should meet the requirements shown below. It is also necessary to add a pull-down resistor R_L connected to ground in order to be able to read 100% of the range of the HF63 voltage output.

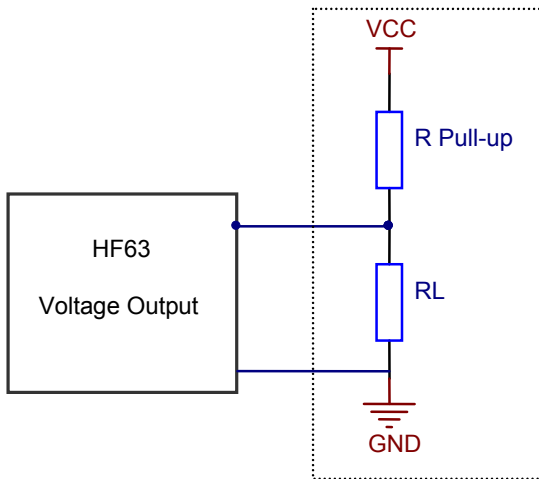

HF63 signal	VCC	R pull-up	RL
0...1V	3.3V	$\geq 250 \text{ k}\Omega$	1 k Ω

HF63 signal	VCC	R pull-up	RL
0...1V	5.0V	$\geq 400 \text{ k}\Omega$	1 k Ω
0...5V	5.0V	$\geq 400 \text{ k}\Omega$	5 k Ω

HF63 signal	VCC	R pull-up	RL
0...1V	10.0V	$\geq 1 \text{ M}\Omega$	1 k Ω
0...5V	10.0V	$\geq 1 \text{ M}\Omega$	5 k Ω
0...10V	10.0V	$\geq 1 \text{ M}\Omega$	10 k Ω

7.2 HF63 transmitters (analog outputs)

If so desired use the HW4 software to configure the HF6. Complete the mechanical and electrical installation and simply power up the HF6.

7.3 HF65 (digital output)

Configuration and full access to all HF65 functions requires a PC with the ROTRONIC HW4 software installed.

Starting with firmware version 1.3, the HF65 offers several communication protocol options that allow users to read the measurement data without the HW4 software. When using the standard RO-ASCII protocol, access to some of the HF65 functions is also possible without HW4. For details, see document **E-M-AC3000-CP**.

IMPORTANT: Depending on the type of digital interface, either the PC or the HF45 must be configured by the user as indicated below.

a) USB network connection

Prior to connecting the HF65 to a USB port you must install the ROTRONIC USB driver on the HW4 PC. For instructions see the HW4 manual **E-M-HW4v2-Main** (§ 6.3)

b) Ethernet (TCP/IP) network connection (wired or wireless)

Prior to connecting the HF65 to an active Ethernet network you must configure the HF65 TCP/IP settings. For instructions see the HW4 manual **E-M-HW4v2-Main** (§ 6.4) and technical note **E-M-TCPIP-Conf**

WARNING: Connecting a device to an active Ethernet network can disrupt communications on the network. Before connecting the HF65, make sure that it is properly configured for your network

E-M-HF63_65-V1_11	Rotronic AG Bassersdorf, Switzerland
Document code	Unit
HygroFlex HF63/HF65 Humidity Temperature Transmitters: User Guide	Instruction Manual
	Document Type
Document title	Page 23 of 34

c) RS-485 serial interface (multi-drop)

Instructions for using the HF65 with a RS-485 network are provided in the following manuals:
E-M-HW4v2-Main (§ 6.5), **E-M-HW4v2-F2-008** and **E-DV04-RS485.01**.

Notes:

- Instruments connected to the same RS-485 network must use the same baud rate and each instrument must be given a unique RS-485 address
- **RS-485 Compatibility:** The communications protocol used by the HF65 and other AirChip 3000 products is not compatible with the protocol used by the previous generation of ROTRONIC products. Do not connect legacy products and AirChip 3000 products to the same RS-485 multi-drop network.

The specifications of the RS-485 interface are as follows:

Baud rate : 19200
Parity : none
Data bits : 8
Stop bits : 1

7.4 Internal menu (optional keypad and display)

Note: Unauthorized access to the menu can be prevented by disabling the “display menu” setting (use the HW4 software > Device Manager > Display)

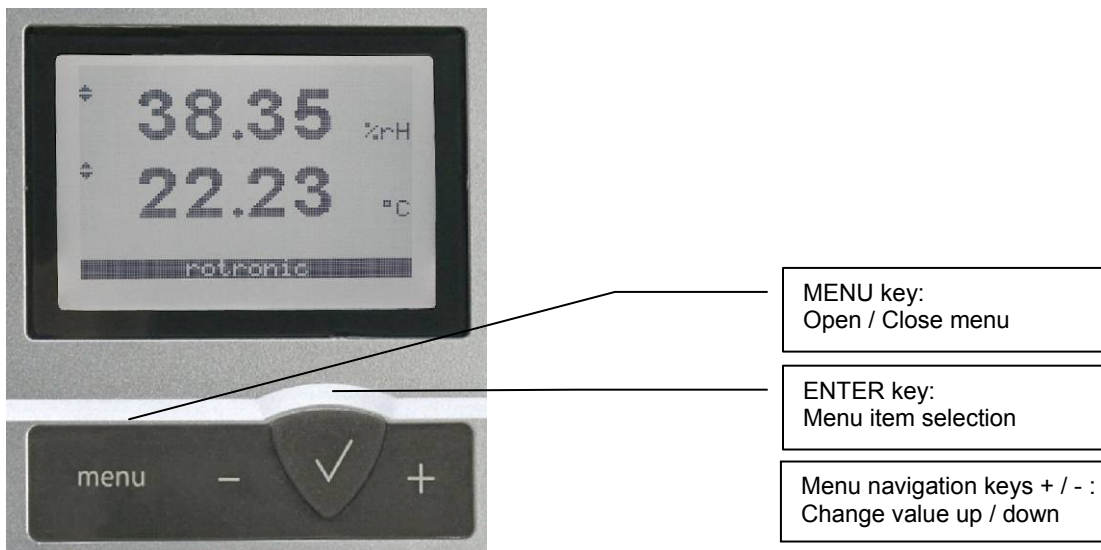

Main Menu	Menu Items	Selections / Information	Notes
Settings			
	Unit	°C / °F	Temperature / dew or frost point
	Record	On / Off	Data recording (max. 2000 values)
	Back Light	Key Press / On / Off	Display backlight mode

E-M-HF63_65-V1_11 Document code	Rotronic AG Bassersdorf, Switzerland Unit
HygroFlex HF63/HF65 Humidity Temperature Transmitters: User Guide Document title	Instruction Manual Document Type
	Page 24 of 34

Main Menu	Menu Items	Selections / Information	Notes
Device Information			
	Version	Firmware version	
	Serial Nbr	Serial number	
	Address	RS-485 address	
	Type	Device type	
	Name	Device name	User defined
	SensorTest	Humidity sensor status	Off / Good / SQ-Tuned / Bad
Humidity Adjust			
	RefValue	Humidity reference value	± 0.1 %RH steps
	<Adjust>		1-point adjustment only (offset)
Temperature Adjust			
	RefValue	Temperature reference value	± 0.1 °C steps
	<Adjust>		1-point adjustment only (offset)

- **Record:** both the recording mode (start / stop and the log interval cannot be changed from the menu and are as configured with the ROTRONIC HW4 software
- **SensorTest:** Off means that the humidity sensor has not been tested due to the configuration settings of the test. For a description of the automatic humidity sensor test and drift compensation (SQ-tuning) see documents **E-T-AC3000-DF-V1** and **E-M-HW4v2-F2-008**

7.5 Displayed parameters (optional keypad and display)

When the menu is not active, press the ENTER key to change which parameters are shown on the display:

- Relative humidity and temperature
- Dew / frost point and temperature (when the calculated parameter is enabled)

8 Maintenance

8.1 Service cable

- Cable AC3006 is used to connect the HF63 or HF65 to a USB port of a PC running the ROTRONIC HW4 software.
- As an alternative, cable AC2001 is used to connect the HF63 or HF65 to a probe input of the HP23 hand-held calibrator. For service purposes, the HP23 offers essentially the same functionality as the HW4 software.

E-M-HF63_65-V1_11 Document code	Rotronic AG Bassersdorf, Switzerland Unit
HygroFlex HF63/HF65 Humidity Temperature Transmitters: User Guide Document title	Instruction Manual Document Type
	Page 25 of 34

8.2 Location of the service connector (mini USB type)

The service connector can be accessed without opening the enclosure after removing the small red sealing cover.

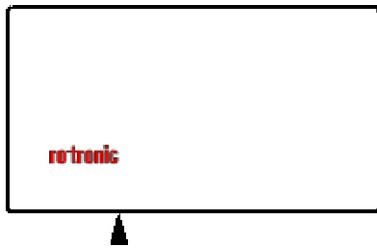

The service connector is located at the bottom of the enclosure (black arrow)

8.3 Periodic calibration check

Both the Pt 100 RTD temperature sensor and associated electronics are very stable and should not require any calibration after the initial factory adjustment.

Long term stability of the ROTRONIC Hygromer humidity sensor is typically better than 1 %RH per year. For maximum accuracy, calibration of the HF6 should be verified every 6 to 12 months. Applications where the HF6 is exposed to significant pollution may require more frequent verifications.

a) Procedure for adjusting the HF63 or HF65 from the optional keypad

The optional keypad allows a 1-point adjustment of temperature or humidity against a reference. A 1-point adjustment has the effect of adding the same offset to all measured values. A multi-point adjustment is not possible from the keypad and requires using either a PC with the HW4 software installed or another instrument such as the HP23 hand-held calibrator.

- When the parameter to be adjusted is stable, press the MENU key to show the internal menu on the display
- Use the (-) key to select either H-Adjust or T-Adjust and press the ENTER key
- Make sure that the text line beginning with RefValue is highlighted and press the ENTER key
- Use the (+) or (-) key to change the reference value as desired
- Use the (-) key to highlight the Adjust text line and press the ENTER key
- The display confirms the adjustment with the message "Adjust OK"
- Press the MENU key twice to exit the menu and return the HF6 to normal operation

b) Procedure for adjusting the HF63 or HF65 with the ROTRONIC HW4 software:

- Use cable AC3006 to connect the service connector to a USB port of a PC with the HW4 software installed. Note that the ROTRONIC USB driver must be installed on the PC as explained in the HW4 manual **E-M-HW4v2-Main**. In the case of the HF65, a connection with the PC can be established via the USB (ROTRONIC USB driver) or Ethernet interface.
- Start HW4 on the PC and search for the transmitter (HW4 Main Menu Bar > Devices and Groups > Search for USB Masters).
- After finding the HF63 or HF65 with HW4, expand the device tree to display all available functions. Select Probe Adjustment.
- For further instructions see HW4 manual **E-M-HW4v2-A2-001**

E-M-HF63_65-V1_11	Rotronic AG Bassersdorf, Switzerland
Document code	Unit
HygroFlex HF63/HF65 Humidity Temperature Transmitters: User Guide	Instruction Manual
	Document Type
Document title	Page 26 of 34

8.4 Cleaning or replacing the dust filter

Depending on the conditions of measurement, the filter should be checked from time to time. Corroded, discolored or clogged filters should be replaced.

- If the probe has a removable cartridge, simply replace the cartridge (leave the metal base on the probe).



- If the probe has a plastic slotted cap with a built-in filter element follow these instructions:
 - 1) Unscrew the filter from the probe and pull it straight away, in the alignment of the probe, so as not to catch the humidity and temperature sensors.
 - 2) Before putting on a new dust filter, check the alignment of both sensors with the probe. The wires that connect the sensors to the probe are very thin and bend easily. If necessary, correct the alignment by tapping the sensor very gently with a smooth object such as a small plastic rod. Do not use sharp pliers or tweezers as this could puncture the sensor and do not pull hard on the sensor.

8.5 Validation of the output signals transmission

If so desired, transmission of the output signals can be validated by using the simulator function. The HW4 software is required to enable and configure this function. When this function is enabled the HF63 or HF65 generates fixed digital and / or analog signals as specified by the user. For instructions see document **E-M-HW4v2-F2-008**

9 Firmware updates

Firmware updates will be available on the ROTRONIC website for downloading. Firmware files are given a name that shows both to which device the file applies and the version number of the firmware. All firmware files have the extension HEX.

Procedure for updating the firmware:

- Use cable AC3006 to connect the service connector to a USB port of a PC with the ROTRONIC HW4 software installed. Note that the ROTRONIC USB driver must be installed on the PC as explained in the HW4 manual **E-M-HW4v2-Main**. In the case of the HF65, a connection with the PC can be established via the USB (ROTRONIC USB driver) or Ethernet interface.
- Copy the firmware update file from the ROTRONIC website to the PC.
- Start HW4 software on the PC and search for the HF63 or HF65 (HW4 Main Menu Bar > Devices and Groups > Search for USB Masters).
- After finding the HF6, expand the device tree to all available functions. Select Device Manager. In the Device Manager menu bar select Tools > Firmware Update. For instructions see document **E-M-HW4v2-F2-008**

E-M-HF63_65-V1_11	Rotronic AG Bassersdorf, Switzerland
Document code	Unit
HygroFlex HF63/HF65 Humidity Temperature Transmitters: User Guide	Instruction Manual
	Document Type
Document title	Page 27 of 34

10 Technical data

10.1 Specifications

General	HF63	HF65
Device type	Humidity temperature transmitter with analog output signals	Humidity temperature transmitter with digital output
Circuit type	3-wire	
Mechanical configuration types	D and W	

Power supply and connections	HF63	HF65
Supply voltage (VDD)	15...40 VDC or 12...28 VAC 85...265 VAC	5...40 VDC or 12...28 VAC 85...265 VAC
Nominal current consumption (low voltage models)	< 50 mA	Model with USB interface: 50 mA Model with Ethernet interface: 300 mA
Cable fittings	Terminal block and M16 cable grip or ½" conduit adapter	Connector (USB or Ethernet), terminal block (power supply and RS-485) and M16 cable grip or ½" conduit adapter
Polarity protection (low voltage models)	Protective diode on V+	

Humidity measurement	HF63	HF65
Sensor	ROTRONIC Hygromer [®] IN1	
Measuring range	0...100 %RH	
Measurement accuracy at 23 °C	±1.0 %RH	
Repeatability	0.3 %RH	
Long term stability	< 1 %RH / year	
Sensor time constant	Typical 10 sec, 63% of a 35 to 80 %RH step change (1m/sec air flow at sensor)	

Temperature measurement	HF63	HF65
Sensor	Pt100 RTD, IEC 751 1/3 class B	
Measuring range limits	-100...150 °C / -148...302 °F	
Measurement accuracy at 23 °C	±0.2 °C	
Repeatability	0.05°C	
Long term stability	< 0.1°C / year	
Sensor time constant	Typical 4 sec, 63% of a step change (1m/sec air flow at sensor)	

Calculated parameters	HF63	HF65
Psychrometric calculations	Dew or frost point (user configurable option)	

E-M-HF63_65-V1_11	Rotronic AG Bassersdorf, Switzerland
Document code	Unit
HygroFlex HF63/HF65 Humidity Temperature Transmitters: User Guide	Instruction Manual
	Document Type
Document title	Page 28 of 34

Start-up time and data refresh rate	HF63	HF65
Start-up time	1.9s (typical)	1.9s (typical)
Data refresh rate	1.7s (typical)	1.7s (typical)

Configurable analog outputs	HF63
Output 1	Can be made to correspond to any parameter
Factory default parameter	Relative humidity or dew / frost point
Factory default scale	As per ordering code
Output 2	Can be made to correspond to any parameter
Factory default parameter	Temperature
Factory default scale	As per ordering code
Output 1 and Output 2	
Signal type (user configurable)	0...20 mA 4... 20 mA 0... 1 V 0... 5 V 0... 10 V
User configurable scaling limits	-999.99 ... +9999.99 engineering units
Maximum offset at bottom of signal range	0...1V signal range : 3 mV 0...5 V signal range : 50mV 0...10 V signal range : 90mV 0...20 mA signal range : 4uA 4...20 mA signal range : no offset
Short circuit tolerant	Yes
Maximum external load	500 Ω (current output)
Minimum external load	1 kΩ (0...1 V output) 5 kΩ (0...5 V output) 10 kΩ (0...10 V output) 0 Ω (current output)

Digital interface	HF65
Interface type	RS-485 or USB + RS-485 or Ethernet (TCP/IP) wired or wireless +RS-485 Can be configured for use with a Modbus BUS system

Service connector	HF63	HF65
Interface type	UART	
Maximum service cable length	5 m (16.4 ft)	

General specifications	HF63	HF65
Optional display	LC, 1 or 2 decimals resolution, backlight, trend and alarm indication	
Probe material	Polycarbonate	
Probe dust filter material	Depends on filter type	
Housing material	ABS	
Housing protection grade	IP 65 (except HF55 – USB or Ethernet)	
Physical dimensions	See Models	
Weight	300 g (10.6 oz)	300 g (10.6 oz)

E-M-HF63_65-V1_11	Rotronic AG Bassersdorf, Switzerland
Document code	Unit
HygroFlex HF63/HF65 Humidity Temperature Transmitters: User Guide	Instruction Manual
	Document Type
Document title	Page 29 of 34

Conformity with standards	HF63	HF65
CE / EMC immunity	EMC Directive 2004/108/EG: EN 61000-6-1: 2001, EN 61000-6-2: 2005 EN 61000-6-3: 2005, EN 61000-6-4: 2001 + A11	
Solder type	Lead free (RoHS directive)	
Fire protection class	Corresponds to UL94-HB	
FDA / GAMP directives	compatible	

Environmental limits	HF63	HF65
Storage and transit	-50...+70 °C / -20...+70 °C (models with display), 0...100 %RH, non condensing	
Operating limits at electronics	-40 ... +60 °C / -10...60 °C (models with display), 0...100 %RH, non condensing	
Temperature limits at probe	-100...+150 °C (valid for type D and type 2 – cable probe)	
Maximum humidity at sensor	100 %RH up to 80 °C (176 °F) 75 %RH at 100 °C (212 °F) 45 %RH at 125 °C (260 °F) 15 %RH at 150 °C (302 °F)	
Maximum air velocity at probe	40 m/s (7,870 ft /min) – depends on dust filter type	
Critical environments	Humidity sensor: as per DV04-14.0803.02 - Critical chemicals	

E-M-HF63_65-V1_11 Document code	Rotronic AG Bassersdorf, Switzerland Unit
HygroFlex HF63/HF65 Humidity Temperature Transmitters: User Guide Document title	Instruction Manual Document Type Page 30 of 34

10.2 Dew point accuracy

The HF6 can be configured to calculate either the dew point or frost point based on the measurement of relative humidity and temperature. The accuracy of this conversion varies, depending on the humidity and temperature conditions as shown in the graph below:

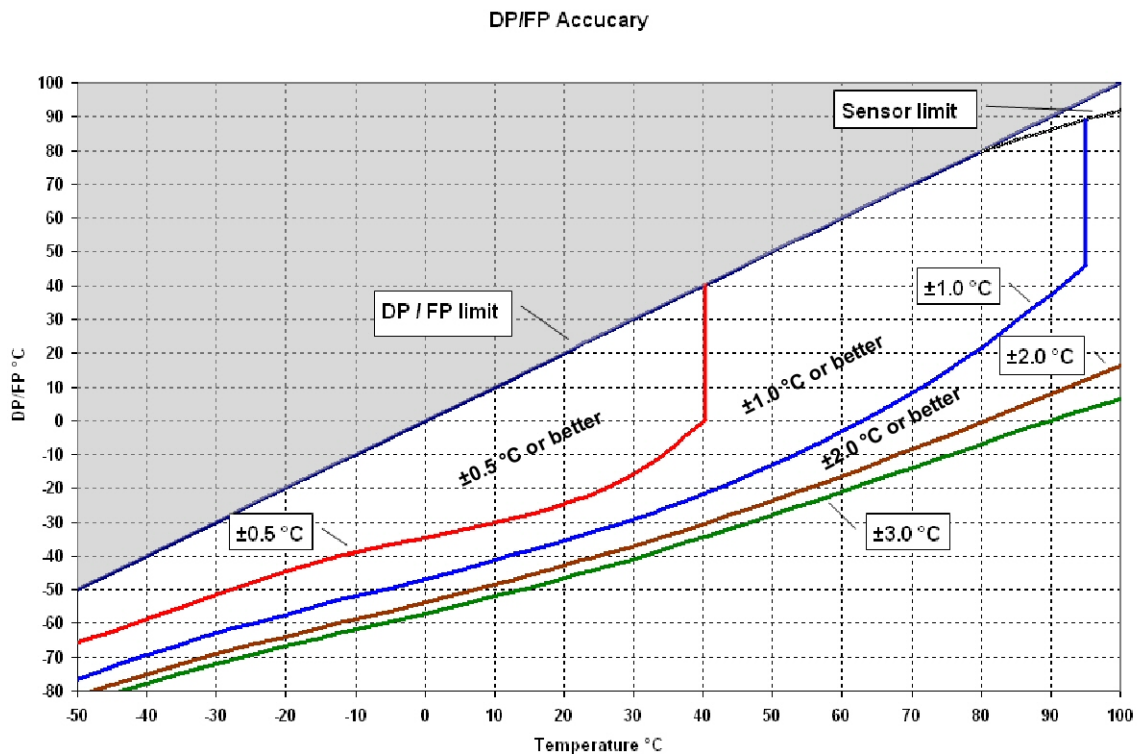

Example: at a temperature of 20 °C, a frost point value of -25 °C is measured with an accuracy of ± 0.5 °C or better.

E-M-HF63_65-V1_11 Document code	Rotronic AG Bassersdorf, Switzerland Unit
HygroFlex HF63/HF65 Humidity Temperature Transmitters: User Guide Document title	Instruction Manual Document Type
	Page 31 of 34



11 Accessories

11.1 Configuration and communication software

The ROTRONIC HW4 software (version 2.1.0 or higher) allows configuring the HF63 or HF65. HW4 is compatible with Windows XP, Vista and NT4 with SP6a or higher. For more details see separate instruction manual provided with the software.

Order Code	Description
HW4-E	HW4 software, Standard Edition (single user)
HW4-P	HW4 Professional Edition, ERES regulations compliant (FDA / GAMP), multi user

11.2 Service cables



Order Code	Description	
AC3006	Mini-USB service connector (UART) to a PC USB port. Cable electronics convert UART interface to USB interface. Approximate length: 1.7 m HF6 must be powered	
AC2001	Mini-USB service connector (UART) to 7-pin probe connector of the HP23 hand-held calibrator or other instrument with display and keypad. Approximate length: 1.7 m HF6 must be powered	

IMPORTANT:

- Prior to using cable AC3006 the ROTRONIC USB driver must be installed on the PC (available from the HW4 CD or from www.rotronic-humidity.com. For installation instructions see document **E-M-HW4v2-Main** (§ 6.3).

E-M-HF63_65-V1_11	Rotronic AG Bassersdorf, Switzerland
Document code	Unit
HygroFlex HF63/HF65 Humidity Temperature Transmitters: User Guide	Instruction Manual
	Document Type
Document title	Page 32 of 34

11.3 Mounting hardware

Order Code	Description	
AC5002	DIN-rail mounting kit consisting of 2 clamps that attach to the back of the enclosure with the screws provided. DIN-rail (35 mm / 1 3/8") not included	
QMA-15	Consists of mounting flange (AC1305) and compression fitting (AC1303-M) for 15 mm / 0.6" diameter probe. Use for tough wall installation of the HF6 type D Maximum temperature 200 °C (392°F)	

11.4 Calibration accessories

Order Code	Description
EA00-SCS	0.5 %RH humidity std, SCS cert., pack of 5
EA05-SCS	5 %RH humidity std, SCS cert., pack of 5
EA10-SCS	10 %RH humidity std, SCS cert., pack of 5
EA20-SCS	20 %RH humidity std, SCS cert., pack of 5
EA35-SCS	35 %RH humidity std, SCS cert., pack of 5
EA50-SCS	50 %RH humidity std, SCS cert., pack of 5
EA65-SCS	65 %RH humidity std, SCS cert., pack of 5
EA80-SCS	80 %RH humidity std, SCS cert., pack of 5
EA95-SCS	95 %RH humidity std, SCS cert., pack of 5
ER-15	Calibration device for 15mm diameter probes



For instructions regarding the ROTRONIC humidity standards and calibration devices see document **E-M-CalBasics**.

11.5 Dust filters for wall mount models

Order Code	Slotted cap	Filter insert	
NSP-PCB-PE	Polycarbonate, black	Polyethylene	
NSP-PCB-WM		Wire mesh	
NSP-PCB-TF		Teflon	

E-M-HF63_65-V1_11	Rotronic AG Bassersdorf, Switzerland
Document code	Unit
HygroFlex HF63/HF65 Humidity Temperature Transmitters: User Guide	Instruction Manual
	Document Type
Document title	Page 33 of 34

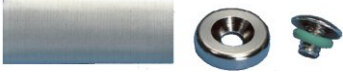
11.6 Dust filter parts for duct mount and cable probe models

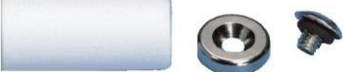
Order Code	Description	
NSP-ME	Filter base Nickel plated brass HC2 thread Filter Cartridge not included	
SP-M15	Wire mesh filter cartridge Use with NSP-ME or SP-MSB15	
SP-S15	Sintered steel filter cartridge Use with NSP-ME or SP-MSB15	
SP-T15	Teflon filter cartridge Use with NSP-ME or SP-MSB15	

E-M-HF63_65-V1_11 Document code	Rotronic AG Bassersdorf, Switzerland Unit
HygroFlex HF63/HF65 Humidity Temperature Transmitters: User Guide Document title	Instruction Manual Document Type
	Page 34 of 34

12 Supporting documents

Document File Name	Contents
E-T-AC3000-DF-V1	AirChip 3000 Description and Main Functions
E-M-HW4v2-DIR	List of the HW4 manuals
E-M-HW4v2-Main	HW4 software version 2: General instructions and functions common to all devices
E-M-HW4v2-F2-008	HW4 software version 2: Device Manager - HF63 and HF65 transmitters
E-M-HW4v2-A2-001	HW4 software version 2: Probe Adjustment function AirChip 3000 devices
E-M-HW4v2-DR-001	HW4 software version 2: Data Recording Function AirChip 3000 Devices
E-M-AC3000-CP	AirChip 3000 Communication Protocol
E-M-TCPIP-Conf	Configuration procedures for ROTRONIC devices with Ethernet (TCP/IP) interface
E-M-CalBasics	Temperature and humidity calibration basics
E-T-HumiDefs	Humidity Definitions Instructions for using the ROTRONIC humidity standards

Note: All document file names have an extension corresponding to the document release number (example of a first release: E-M-HW4v2-Main_10). This extension is not shown in the above table.

13 Document releases

Doc. Release	Date	Notes
_10	Dec. 8, 2008	Original release
_11	Feb.4, 2009	Deleted service cables AC3008 and AC3009 Reference to HW4 manuals: changed the file name of all documents such as E-M-HW4v2.1-Main to E-M-HW4v2-Main